



Désignation	Code constructeur	Ref FHS
<b>Commande principale complète</b>		3018088
<b>Boîtier de commande câblé (75052)</b>		3018090
<b>Commande principale complete</b>		3018104G
<b>Façade de commande complete Tasterplatte3+1K</b>		3018114G
<b>Coffret de commande complet pour 750S2</b>		3018116G
<b>Commande principale complete EVO7000</b>	 BAR	3018139G
<b>Commande principale complete EVO BG 7000</b>	 BAR	3018140G



Désignation		Code constructeur	Ref FHS
<b>Recepteur radio 4 fonctions</b>		BAR	2241003G
<b>Kit radio commande 4 canaux</b>			3019332
<b>emetteur radio 4 canaux</b>			3019334
<b>Commande annexe 4 boutons</b>			3019337G
<b>Commande interieure 2BP encastrable</b>			3019341G
<b>Commande annexe 2 boutons</b> commande aimantée		BAR	3019346BARG
<b>Kit radio commande 2 canaux</b>			3019352G
<b>Kit commande annexe 4 boutons</b>			3019354G





Désignation	Code constructeur	Ref FHS
Commande smart control		3019370G
		
Commande annexe 4 boutons	BAR	3019413G
		
Kit commande aux pieds		3020023
		
Recepteur radiocommande	BAR	3021009
		
Kit radio commande 2 canaux		6011234G
		
Kit radiocommande	BAR	6011235G
		
Kit radio commande 2 fonctions	BAR	6011306G
		



Désignation	Code constructeur	Ref FHS
Carte électronique 6 relais		3022076
		
Carte électronique S2		3022077
		
Carte électronique + kit fusible		3022079
		
Carte électronique H42 / R42 / R41		3022086G
		
Carte électronique		3022090G
		
Carte électronique EBC - controller maxi		3022095G
		
Carte électronique ZA Alpha-1/BC2000S4U-C1/RA1/R4S		3022096G
		
Carte électronique		3022109G
		











Désignation	Code constructeur	Ref FHS
<b>Manocontact pression + faisceau</b>	BAR	2210025G
		
<b>Micro relais 24volts 5 broches</b> ( FRC7C-S)		3015015
		
<b>Micro relais 12 volts 5 broches</b>		3015021
		
<b>Faisceau + manostat</b>		3017025
		
<b>Boitier de connectique plateforme</b> toberone		3017035
		
<b>Capteur de proximité</b>		3017038
		
<b>Capteur de proximité PNP</b>		3017039
		
<b>Capteur de proximite PNP NC</b>		3017048G
		





Désignation	Code constructeur	Ref FHS
<b>Electronique de commande aux pieds</b> BC750A2L		3017054G
<b>Electronique de commande aux pieds</b> CAN ARC 1	BAR 	3017055G
<b>Capteur angulaire</b> CAN Cargowam ARC3		3017056G
<b>Commuteur a pression huile</b> pour BC750S2		3017057G
<b>Electronique de commande aux pieds</b>		3017058G
<b>Initiateur de proximite</b> Molex - H42 - EBC		3017060G
<b>Initiateur de proximite PNP NC</b>		3017061G
<b>Capteur proximite + faisceau</b>	BAR 	3017064G



Désignation	Code constructeur	Ref FHS
<b>Initiateur electronique de la commande aux pieds</b>	BAR	3017066G
		
<b>Electronique de commande aux pieds</b>		3017071G
		
<b>Commande au pied H pour cycle montée</b>		3020022
		
<b>Commande au pied S pour cycle descente</b>		3020027
		
<b>Electronique de commande aux pieds</b>		3020029G
		
<b>Recepteur radiocommande smart control</b>	BAR	3022119G
		
<b>Pointe de contact</b>		3024157G
		
<b>Pointe de contacteur puissance 25+ 35+</b>	BAR	3025053G
		



Désignation	Code constructeur	Ref FHS
Douille de contact puissance 25+ 35+		3025054G
		
Bloc contact		3025056G
		
Bloc de contact		3025057G
		
Commutateur de mise sous tension		3025060G
		
Commutateur externe a clé + faisceau Lg 7.5 m	BAR	3025061G
		
Micro commutateur pour commande au pied		3026048
		
Bloc contact manipulateur		3026050G
		
Bloc contact manipulateur		3026051G
		



Désignation	Code constructeur	Ref FHS
Interrupteur cabine avec voyant 12 volts		3027038
		
Interrupteur cabine avec voyant 24 volts		3027041
		
Contacteur de commande au pied		3027046
		
Temoin de charge	BAR	3027071G
		
Manipulateur 2 positions droite équipé		3029021
		
Manipulateur 4 positions droite		3029030
		
Manipulateur 4 positions gauche		3029031
		
Manipulateur 2 positions gauche équipé		3029035
		



Désignation	Code constructeur	Ref FHS
Joystick de commande 2 fonctions	BAR	3029043G
Joystick de commande 4 fonctions	BAR	3029049G
Initiateur de proximité		3137030G
Feu de plateforme 12/24volts		3311033
Feu eclaireage de plaque immatriculation		3311040G
Feu arriere gauche		3311041G
Feu arriere droit		3311042G
Feu lateral de plateforme	BAR	3311055G





Désignation	Code constructeur	Ref FHS
<b>Aimant de détection</b>		<b>5314007</b>











Désignation		Code constructeur	Ref FHS
Fiche connecteur Molex 4 entrees		BAR	3026053G
Faisceau adaptateur boitier de commande		BAR	3037038G
Fiche connecteur Molex 6 entrees		BAR	3111032G
Faisceau + prise CAD			3137006
Faisceau de plateforme			3137008
Faisceau de plateforme		BAR	3137013G
Faisceau alimentation inter-cabine avec connecteurs		BAR	3137014G
Faisceau puissance + connecteurs			3137016G







Désignation		Code constructeur	Ref FHS
Faisceau Sensor		BAR	3137017G
Faisceau liaison plateforme électronique cde aux pieds			3137021G
Cable de liaison feux clignotants			3137022G
Faisceau liaison feux commande aux pieds			3137023G
Faisceau liaison plateforme			3137024G
Faisceau de liaison commande aux pieds			3137025G
Faisceau de plateforme S4			3137027G
Faisceau alimentation avec VDHH			3137028G



Désignation	Code constructeur	Ref FHS
<b>Faisceau de connection</b>		3137029G
		
<b>Faisceau alimentation puissance négatif</b> faisceau + connecteur sur groupe electropompe		3137031G
		
<b>Faisceau alimentation + connecteur</b> manocontact de pression		3137032G
		
<b>Faisceau alimentation + connecteurs</b>		3137034G
		
<b>Faisceau alimentation</b> sur groupe hydraulique		3137035G
		
<b>Faisceau alimentation + connecteur</b>		3137036G
		
<b>Faisceau alimentation + connecteur</b>		3137037G
		
<b>Faisceau alimentation puissance positif</b> faisceau + connecteur sur groupe electropompe		3137039G
		



Désignation	Code constructeur	Ref FHS
<b>Faisceau alimentation feux de plateforme</b> faisceau jonction entre feux		3137040G
<b>Faisceau adaptateur</b>		3137041G
<b>Faisceau de plateforme</b>		3137046G
<b>Faisceau puissance négatif + connecteur</b>	france <b>hayon</b>	3137048G
<b>Faisceau carte EBC/groupe hydraulique</b>	BAR 	3137049G
<b>Faisceau électrique coffret commande - carte</b>	BAR france <b>hayon</b>	3137053G
<b>Cable + témoin cabine 12volts</b> avec VDHH+stecker+FHE		3137058G
<b>Faisceau commande de secours carte EBC</b>	BAR 	3137059G



Désignation		Code constructeur	Ref FHS
<b>Faisceau + prise CAD Lg 7.5 m</b>		BAR	3137069G
<b>Faisceau feux de signalisation droite</b>		BAR	3137081G
<b>Faisceau de branchement feux arrière gauche</b>		BAR	3137084G
<b>Connecteur de puissance nu male - positif</b>			3138003G
<b>Connecteur de puissance nu male - negatif</b>			3138004G
<b>Connecteur de puissance nu femelle (negatif)</b>			3138005G
<b>Connecteur de puissance nu male (negatif)</b>			3138006G
<b>Fiche connecteur 2 entrees</b>		BAR	4114240G







Désignation	Code constructeur	Ref FHS
Fiche connecteur Molex 10 entrees	BAR	6011244G

---







Désignation	Code constructeur	Ref FHS
<b>Porte fusible équipé 15A</b>		3119027
		
<b>Kit fusible puissance 150A</b> fusible carré		3210040G
		
<b>Fusible puissance 150A</b>		3210041G
		
<b>Fusible puissance 50A</b>		3210043G
		
<b>Kit fusible de puissance 150A</b> pour Atego		6011264G
		





Enveloppes de commande

Désignation	Code constructeur	Ref FHS
<b>Boitier nu</b> 		<b>4114198</b>
<b>Boitier nu</b> 		<b>4114199</b>
<b>Capot pour interface electrique</b> 	<b>BAR</b>	<b>4114239G</b>

**BAR**



**POSTES DE COMMANDE**

**ACCESSOIRES DE COMMANDE**

Façades

Désignation

Code constructeur

Ref FHS

Pour toutes vos commandes : **02 99 00 75 75**

france **hayon**



Désignation	Code constructeur	Ref FHS
<b>Plaque d'instruction EVO F4 droite</b> 	BAR	
<b>Passerelle</b> 		1130030G
<b>Clé de mise sous tension</b> 		3024125
<b>Coiffe poussoir commande au pied</b> H montée 		3024137
<b>Coiffe poussoir commande au pied</b> S descente 		3024138
<b>Poignée de manipulateur</b> 		3024139
<b>Coiffe bouton commande au pied</b> 		3024140
<b>Caoutchouc de manipulateur</b> 		3024141



Autres

Désignation	Code constructeur	Ref FHS
Clé de mise sous tension		3024144
		
Connecteur APD 7 pôles (femelle)		3110079G
		
Connecteur APD 7 pôles ( mâle)		3110080G
		
Obturateur		3137042G
		
Adhesif instruction S2/A2L droite		3314067
		
Adhesif consigne de securite		3314068
		
Adhesif plaque signaletique CARGOLIFT		3314070G
		
Plaque d'instruction EVO H42 droite	BAR	3314077G
		



Autres

Désignation	Code constructeur	Ref FHS
<b>Plaque d'instruction EVO A2L/S2</b> 	BAR	3314078G
<b>Plaque d'instruction EVO falt droite</b> 	BAR	3314079G
<b>Plaque d'instruction Retfalt droite</b> 	BAR	3314080G
<b>Plaque d'instruction EVO R42 droite</b> 	BAR	3314081G
<b>Plaque d'instruction EVO S4U droite</b> 	BAR	3314082G
<b>Plaque d'instruction EVO F4 droite</b> 	BAR	3314086G
<b>Plaquette de service EVO</b> 	BAR	3314088G
<b>Plaquette de contrôle EVO</b> 	BAR	3314089G



Autres

Désignation	Code constructeur	Ref FHS
Plaque EVO pour plaquette de contrôle	BAR	3314090G
		
Adhesif instructions utilisation cde aux pieds		3315023G
		
Passe cable 3xØ6mm		3912002G
		
Support pour électronique commande aux pieds	BAR	4010406G
		
Fixation pour électronique de commande aux pieds	BAR	4010563G
		
Support toblerone		4010570G
		
Support boîtier de commande EVO	BAR	4010600G
		
Angle pour support boîtier de commande	BAR	4011310G
		



Autres

Désignation		Code constructeur	Ref FHS
<b>Equerre sur prise plateforme</b>		BAR	4012496G
<b>Couvercle de boitier</b>		BAR	4114200
<b>Support recepteur</b>			4115094G
<b>Support boitier commande annexe</b>			4122042
<b>Support recepteur</b>			4122062G
<b>Support boitier de commande</b>			4122063G
<b>Embase de commande au pied</b> CAP			5013041
<b>Support carte électrique</b>			5013048G



Autres

Désignation		Code constructeur	Ref FHS
<b>Ecrou de serrage conique</b>		BAR	5122020G
<b>Ecrou d'isolation fusible puissance</b>		BAR	5128026G
<b>Pochette emetteur radio + sangle</b>			5218249G
<b>Presse étoupe</b> M20X150			5225007
<b>Joint etancheite coffret</b>			5233021G
<b>Presse etoupe</b> M20X1.50			5233022G
<b>Butoir protection CAP</b> Ø54mm - ht16mm - perce Ø6.5mm		BAR	5315019
<b>Tampon borgne</b> pour connecteur 7 pôles			5315034G





Autres

Désignation	Code constructeur	Ref FHS
-------------	-------------------	---------

**Adhesif instructions utilisation**  
R41 R4T R2T



5414150G



Relais

Désignation		Code constructeur	Ref FHS
Relais moteur 24V		BAR	3012057G
Relais moteur 12V 200 A		BAR	3012065G
Relais moteur 24V 150 A		BAR	3012070G



Désignation	Code constructeur	Ref FHS
<p><b>Moteur électrique 24 volts</b> moteur bipolaire 2000watts pour centrale Haldex H.A.</p>		3010190G
<p><b>Moteur électrique 24 volts</b> moteur bipolaire 2000Watts pour centrale Haldex HX</p>		3010191G
<p><b>Moteur électrique 24 volts</b> moteur bipolaire 2200Watts pour centrale Flutec</p>		3010195G
<p><b>Moteur électrique 12volts</b> moteur bipolaire 800Watts</p>		3010204G
<p><b>Moteur électrique 24 volts</b> moteur bipolaire 1200 watts</p>		BAR 3010219G

**BAR**



**CENTRALES HYDRAULIQUES**

**COMPOSANT ÉLECTRIQUES**

Sous-ensembles

Désignation





Code constructeur

Ref FHS

Pour toutes vos commandes : **02 99 00 75 75**

france **hayon**



Désignation	Code constructeur	Ref FHS
<b>Centrale hydraulique 24v- 2000Watts</b> montage FLUTEC		2012051
<b>Centrale hydraulique 12volts</b>		2012054
<b>Centrale hydraulique 24volts</b>		2012066G
<b>Centrale hydraulique 24 volts</b>	BAR 	2012067G







Désignation	Code constructeur	Ref FHS
<b>Pompe à engrenages 2 Cm3/tr</b>	BAR	1010095G
		
<b>Pompe à engrenages 1.2 Cm3/tr</b> montage Haldex type H.A.	BAR	1010098G
		
<b>Pompe à engrenages 2 Cm3/tr</b> version adaptable montage Haldex type H.A.	BAR DAUTEL	1010100C
		
<b>Pompe à engrenages 2 Cm3/tr</b> montage Haldex type H.A.	BAR	1010100G
		
<b>Pompe à engrenages 2.5 Cm3/tr</b> montage Haldex		1010101G
		
<b>Pompe à engrenages 1.2 Cm3/tr</b> montage Flutec	BAR	1010102G
		
<b>Pompe à engrenages 0.75 Cm3/tr</b>	BAR	1010119G
		
<b>Pompe à engrenages 2.6 Cm3/tr</b> pour centrale FLUTEC	BAR	1010121G
		



Désignation	Code constructeur	Ref FHS
Pompe à engrenages	BAR	1010133G
Pompe à engrenages		1010218G
Pompe à engrenages 2.5 Cm3/tr		1010219G
Interface de pompe	BAR	1115074G



Désignation	Code constructeur	Ref FHS
<b>Bloc distributeur nu</b> bloc de fonction sortie		1115068G
<b>Bloc de retraction + corps electro</b>		2111127G
<b>Bloc distributeur équipé</b>		2111132G
<b>Electro-vanne VLB 24 volts filaire</b> M20X150		2112167G
<b>Electro-valve 4/2 24volts</b> M20X150		2112209G





Désignation	Code constructeur	Ref FHS
<p><b>Distributeur 2/2 VLB M20x150</b> nezØ:15mm - tigeØ18mm</p> 	BAR	1020034G
<p><b>Distributeur 4/2 M20x150</b> Ø nez 14mm - Ø tige bobine 18mm</p> 		1020074G
<p><b>Selecteur de circuit en 1/4</b></p> 		1122170G



Désignation	Code constructeur	Ref FHS
<b>Bobine 12V Ø18 H 40 Filaire Lg 4550 mm</b>		<b>3014117</b>
		
<b>Bobine 24V Ø18 H 40 Filaire Lg 4550 mm</b>		<b>3014118</b>
		
<b>Bobine 12V Ø18 H 40 Kostal M27</b>	BAR	<b>3014119</b>
		
<b>Bobine 12/24V Ø18 H 40 Filaire</b>	BAR	<b>3014130G</b>
		
<b>Bobine 24V Ø18 H 40 Filaire</b>	BAR	<b>3014131G</b>
		
<b>Bobine 24V Ø18 H 40 Filaire</b> Connecteur EBC	BAR	<b>3014132G</b>
		
<b>Bobine 12V Filaire 4500 mm</b> connecteur EBC	BAR	<b>3014133G</b>
		

**BAR**



**CENTRALES HYDRAULIQUES**

**COMPOSANTS HYDRAULIQUES**

Moteurs hydrauliques

Désignation



Code constructeur

Ref FHS

Pour toutes vos commandes : **02 99 00 75 75**

france **hayon**



Désignation	Code constructeur	Ref FHS
Réservoir BC2000R2T		1110123G
		
Réservoir pour BC750SC2		1110137G
		
Réservoir plastique	BAR	1110138G
		



Capots

Désignation	Code constructeur	Ref FHS
-------------	-------------------	---------

<b>Capot de groupe HE</b> 130x145mm Ep 45mm		
--	--	--

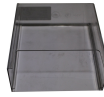

4114238G



Désignation	Code constructeur	Ref FHS
<b>Coffre de groupe electropompe (750DaN)</b> 480x170x160mm	 BAR	<b>4114234G</b>



Désignation		Code constructeur	Ref FHS
<b>Durite de retour + filtre d'aspiration</b>		BAR	1111023G
<b>Conduite d'aspiration pour pompe</b>		BAR	1113019G
<b>Raccord d' orientation</b>			1119026
<b>Bouchon de réservoir</b>			1122142
<b>Limiteur de pression</b>		BAR	1211014G
<b>Passerelle câble perforée</b>			3912001G
<b>Kit fixation réservoir</b>		BAR	6011278G





Désignation	Code constructeur	Ref FHS
<b>Vérin de levage S.E.</b> Øtige 85mm		1015235
		
<b>Verin levage</b>	BAR	1015264G
		
<b>Vérin de levage S.E.</b>		1015269G
		
<b>Verin de levage</b>	BAR	1015286G
		
<b>Verin de levage</b>	BAR	1015339G
		
<b>Verin de levage</b>	BAR	1015564G
		
<b>Verin de levage</b> pour BC 1000S2		1015565G
		









Désignation	Code constructeur	Ref FHS
Verin inclinaison	BAR	1015254G
		
Verin inclinaison	BAR	1015272G
		
Vérin d'inclinaison	BAR	1016189G
		
Verin inclinaison	BAR	1016195G
		



Désignation	Code constructeur	Ref FHS
Vérin de rétraction		1016178G
		
Verin de retraction	BAR	1016186G
		



Désignation		Code constructeur	Ref FHS
<b>Anneau d'étanchéité</b>		BAR	5214019G
<b>Pochette de joints EZ85-230</b>		BAR	5218219
<b>Pochette de joints Ø50</b>		BAR	5218244G
<b>Pochette de joints pour EZ (VL) 70-171/231/28</b>		BAR	5218246G
<b>Pochette de joints pour DZ 90/50-242 - WE</b>		BAR	5218247G
<b>Pochette de joints pour EZ 60-285</b>		BAR	5218248G



Désignation	Code constructeur	Ref FHS
<b>Tige de vérin levage Ø65mm 450mm a l'axe</b> BC20002T-P3 BC1500F2-L2 BC1500S2-K3 BC1500R21-K2	francehayon	4012440G
<b>Tige de vérin</b>	 BAR	4012441G
<b>Rallonge de vérin inclinaison</b> Lg350mm a l'axe - passage axe Ø35mm	 BAR	4012444G
<b>Rallonge de vérin inclinaison</b> Lg 170mm a l'axe - passage axe Ø40mm		4012535
<b>Entretoise de vérin de rétraction</b>	 BAR	4012640G
<b>Collier métal 80x100</b>		5126036
<b>Collier métal 60x80</b>		5126041
<b>Collier 100x120</b>		5126042











Désignation	Code constructeur	Ref FHS
<b>Soufflet de verin</b> Ø70 x 55mm	BAR	5226009G
<b>Fourreau de protection vérin levage</b> coté gauche		5226019
<b>Soufflet de protection verin</b> Ø60x100-Lg370mm pour vérin de levage		5226031
<b>Soufflet de protection verin</b> Ø60 - Ø80mm Lg450mm		5226032
<b>Fourreau de protection vérin de levage</b>	BAR	5226034
<b>Fourreau de protection vérin d'inclinaison</b>	BAR	5226039
<b>Fourreau de protection verin levage</b>		5226042G
<b>Soufflet de protection verin</b>		5226048G









Désignation	Code constructeur	Ref FHS
<b>Soufflet de protection verin</b> + colliers		<b>5226049G</b>
<b>Fourreau de protection verin</b>	 BAR	<b>5226050G</b>



Désignation	Code constructeur	Ref FHS
<b>Flexible H.P. 2ETM10 à 90°</b> Lg 1000mm		1123129
<b>Flexible H.P. 1ETM10à90° + 1ETM10 droit</b> Lg 1300mm		1123130
<b>Flexible H.P. 1ETM10à90°+1ETM10droit</b> Lg 1470mm		1123131
<b>Flexible H.P. 2ETM10</b> Lg 2000mm		1123132
<b>Flexible H.P. 1ETM10à90°+1ETM10droit</b> Lg 2150mm		1123133
<b>Flexible H.P. 1ETM10à90°+1ETM10droit</b> Lg 2410mm		1123134
<b>Flexible H.P. 1ETM10à90°+1ETM10droit</b> Lg 380mm		1123135
<b>Flexible HP Lg 680mm</b>	BAR 	1123162G



Désignation	Code constructeur	Ref FHS
<b>Flexible HP</b>	BAR	1123163G
		
<b>Flexible H.P.</b>	BAR	1123164G
		
<b>Flexible hydraulique 2x DKOL 10L Lg 2330 mm</b>	BAR	1123165G
		
<b>Flexible hydraulique 2x DKOL 10L Lg 2030 mm</b>	BAR	1123166G
		
<b>Flexible hydraulique DKOL 10 L 1 x 90°</b>	BAR	1123167G
		
<b>Flexible hydraulique 2x dkol 10L. Lg 900mm</b>	BAR	1123168G
		
<b>Flexible HP 2 X DKOL 10L Lg 1650mm</b>	BAR	1123198G
		







Désignation		Code constructeur	Ref FHS
Raccord hydraulique male - male		BAR	1117074G
Raccord hydraulique 1/4		BAR	1117080G
Raccord hydraulique (union coudee)		BAR	1117081G
Raccord hydraulique (union)		BAR	1117082G
Raccord hydraulique en T		BAR	1117083G
Raccord hydraulique		BAR	1117084G
Raccord hydraulique male - femelle		BAR	1117085G
bouchon obturateur metal		BAR	1122015G



Désignation	Code constructeur	Ref FHS
<p><b>Vis creuse</b></p> 		1122123
<p><b>Freineur Ø2.4 mm</b> 6.6lt/mn</p> 		1210003
<p><b>Freineur Ø1.6 mm</b> 3.00lt/mn</p> 		1210016
<p><b>Freineur Ø1.7 mm</b></p> 		1210019G
<p><b>Freineur Ø1.1 mm</b></p> 		1210023G
<p><b>Freineur Ø2.3 mm à visser</b></p> 	BAR	1210024G
<p><b>Freineur Ø1.3 mm</b></p> 	BAR	1210025G
<p><b>Rondelle chapeau freineur</b></p> 	BAR	1211009



Désignation	Code constructeur	Ref FHS
<b>Clapet anti-retour</b>	BAR	1213021G
		
<b>Bague BS10 large</b>		5214006G
		

**BAR**



**STRUCTURES ET ARTICULATIONS**

**SOUS-ENSEMBLES**

**MÉCANO-SOUDÉS**

Poutres

Désignation

Code constructeur

Ref FHS

Pour toutes vos commandes : **02 99 00 75 75**

france **hayon**

**BAR**



**STRUCTURES ET ARTICULATIONS**

**SOUS-ENSEMBLES**

**MÉCANO-SOUDÉS**

Cadres

Désignation

Code constructeur

Ref FHS

Pour toutes vos commandes : **02 99 00 75 75**

france **hayon**









Désignation		Code constructeur	Ref FHS
<b>Support pour traverse arrière</b>		BAR	4010052G
<b>Patin de glissiere</b>			4010560G
<b>Console de flasque groupe coté droite</b>		BAR	4010562G
<b>Plaque support BAE</b>		BAR	4010565G
<b>Plaque ecartement</b>		BAR	4010566G
<b>Plaque de montage court pour Springster Craft</b>		BAR	4010567G
<b>Console</b>		BAR	4010568G
<b>Barette</b>		BAR	4010569G





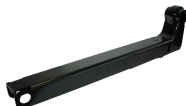





Désignation		Code constructeur	Ref FHS
<b>Plaque de serrage</b> 50X6X180mm		BAR	4010571G
<b>Plaque de serrage</b>		BAR	4010572G
<b>Logement du palier pour bras porteur</b>		BAR	4010573G
<b>Plaque</b>		BAR	4010574G
<b>Support pour capteur</b>		BAR	4010575G
<b>Support</b>		BAR	4011289G
<b>Base pour flasque</b>		BAR	4011307G
<b>Support de groupe</b>		BAR	4011311G



Désignation	Code constructeur	Ref FHS
<b>Carter protection verin</b>	BAR	4011322G
		
<b>Pignon - roue dentee</b>	BAR	4012069G
		
<b>Entretoise alu</b> 60x40mm Lg860mm		4012442G
		
<b>Levier de verin hydraulique</b>	BAR	4012447G
		
<b>Plaque d'appui</b> pour free access	BAR	4013064G
		
<b>Bras de levage</b>	BAR	4112060G
		
<b>Bras de levage</b> BC750S2	BAR	4112076G
		
<b>Bras porteur</b>	BAR	4112077G
		









Désignation		Code constructeur	Ref FHS
<b>Bras de levage</b>		BAR	4112078G
<b>Bras porteur interieur</b>		BAR	4112079G
<b>Bras porteur exterior</b>		BAR	4112080G
<b>Bras de levage</b> EA 800mm		BAR	4112092G
<b>Bras porteur distance LB800</b>		BAR	4112098G
<b>Bras de levage</b> EA800mm		BAR	4112099G
<b>Bras de levage</b>		BAR	4112101G
<b>Bouchon de poutre</b>			4114016



Désignation		Code constructeur	Ref FHS
<b>Support galet de roulement</b>		BAR	4116465G
<b>Partie latérale barre anti encastrement</b>		BAR	4119027G
<b>Barre anti encastrement</b> Ø114 Lg 1900 mm BC750S2		BAR	4119028G
<b>Plaque de serrage barre anti encastrement</b> element en aluminium			4122058G
<b>Bascule gauche BCS4</b>		BAR	4122101G
<b>Bascule droite BCS4</b>		BAR	4122102G
<b>Charnière de PF retractable extérieur</b>		BAR	5013050G
<b>Vis HM12x200mm</b>		BAR	5110063G







Désignation	Code constructeur	Ref FHS
<p><b>Vis HM 8-16mm</b> vis de flasque</p>	 <p>BAR</p>	5110080G
<p><b>Collier de serrage pour bouchon poutre</b> c7/w4</p>		5126054
<p><b>Collier barre de torsion Ø16/18 Ep12mm</b></p>	 <p>BAR</p>	5126060G
<p><b>Collier barre de torsion Ø16/18 Ep 8 mm</b></p>	 <p>BAR</p>	5126062G
<p><b>Patin de glissement</b></p>		5229072



Désignation	Code constructeur	Ref FHS
<b>Axe</b> Ø12mm Lg110mm		4012391
<b>Axe Ø40mm Lg155</b> goupille Ø12	BAR	4012409G
<b>Axe pour galet</b> Ø35 Lg155mm	BAR	4116359G
<b>Axe de Kopf</b> Ø14mm-Lg84mm	BAR	4116367
<b>Axe Ø35 Lg 84mm</b>	BAR	4116372
<b>Axe Ø35 Lg 136mm</b> goupille Ø10mm	BAR	4116377
<b>Axe Ø35 Lg 168mm</b> goupille Ø10mm	BAR	4116378
<b>Axe Ø35 Lg utile 105 mm</b> goupille Ø10	BAR	4116405G









Désignation		Code constructeur	Ref FHS
<b>Axe Ø35 Lg 127mm</b> axe alu à goupille Ø10mm		BAR	4116407G
<b>Axe Ø40 Lg 145mm</b>			4116425G
<b>Axe Ø40 Lg 130mm</b> goupille Ø8mm		BAR	4116435G
<b>Axe Ø35 Lg 180mm</b> goupille Ø8mm		BAR	4116441G
<b>Jeu d'axes + galets</b>		BAR	4116442G
<b>Axe Ø22 Lg 65mm</b> axe à plaquette + graisseur		BAR	4116443G
<b>Axe Ø30 Lg 90mm sous plaquette</b>			4116444G
<b>Axe Ø35 Lg 112mm</b> goupille Ø10mm		BAR	4116445G









Désignation		Code constructeur	Ref FHS
<b>Axe Ø35 Lg 90mm</b> goupille Ø8mm		BAR	4116446G
<b>Axe Ø35 Lg 180mm</b> axe alu à goupille Ø10mm		BAR	4116447G
<b>Axe pour galet de roulement</b> axe Ø35/30mm Lg180mm			4116448G
<b>Axe Ø20 Lg 124mm</b>		BAR	4116449G
<b>Axe pour galet de roulement</b> Ø35mm Lg 106mm		BAR	4116450G
<b>Axe pour galet de roulement</b> Ø35/30mm Lg141mm goupille Ø8mm		BAR	4116451G
<b>Axe pour galet de roulement</b> Ø30/35-Lg totale 156mm-Lg utile 125mm-goupille Ø10mm		BAR	4116452G
<b>Axe Ø35 Lg 90 mm</b> axe a plaquette soudee		BAR	4116453G



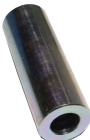







Désignation		Code constructeur	Ref FHS
<b>Axe Ø40 Lg 175mm</b> axe a goupille Ø12mm		BAR	4116454G
<b>Axe pour galet de roulement</b> Ø40 Lg135mm		BAR	4116455G
<b>Axe Ø35 Lg 129 mm</b>		BAR	4116487G
<b>Axe Ø35 Lg 102mm</b> axe a goupille Ø12mm		BAR	4116493G
<b>Axe pour galet</b> Ø40 Lg 175mm		BAR	4116520
<b>Axe Ø35 Lg 155mm</b> axe a goupille Ø12		BAR	4116591G



Désignation		Code constructeur	Ref FHS
<b>Bague Ø20x23x30</b>		BAR	4011309G
<b>Bague de synchronisation</b> Ø44x40xLg40mm			4011324G
<b>Entretoise Ø10mm</b>		BAR	4012328
<b>Entretoise Ø16 x 30 Lg 86mm</b>		BAR	4012407G
<b>Bague à collerette</b> Ø30 x 34 Lg 16mm		BAR	4012408G
<b>Bague entretoise</b>		BAR	4012446G
<b>Entretoise Ø16.5 x 30 Lg 104mm</b>		BAR	4012448G
<b>Entretoise Ø30 x 16.3 Lg 132mm</b>		BAR	4012450G

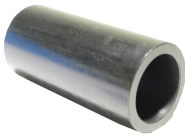



Désignation		Code constructeur	Ref FHS
<b>Bague Ø45x40 Lg80mm</b>			5210082
<b>Bague de synchronisation</b> Ø40,5 x 35 Lg 65mm		BAR	5210088
<b>Bague Ø42 x 35 Lg 50mm</b>		BAR	5210114G
<b>Bague Ø40 x 29 Lg 120.50</b>			5210115G
<b>Bague Ø40 x 30 Lg 86mm</b>		BAR	5210116G
<b>Bague d'ecartement</b> Ø50x35,5 ep6mm		BAR	5210117G
<b>Bague bronze à collerette</b> Ø45 x 41 ep 17mm		BAR	5210124G
<b>Bague Ø42,5 x 35,5 Lg 50mm</b>		BAR	5210128G



Désignation	Code constructeur	Ref FHS
-------------	-------------------	---------

**Bague**  
Ø48,5/40mm Lg50mm





BAR

**5210146G**







Désignation		Code constructeur	Ref FHS
<b>Coiffe protection graisseur</b>		BAR	4114232G
<b>Vis TH 8-30 mm</b> crantée Q8.8 zn		BAR	5110052G
<b>Vis HM 8-10</b>		BAR	5110073G
<b>Vis FHC M6-25</b>		BAR	5110077G
<b>Vis à tête hexagonal</b>		BAR	5110079G
<b>Vis HM 5-20</b>		BAR	5110081G
<b>Vis HM16- 140 mm</b> Lg filetée 50mm - Q8.8 - Zn		BAR	5110313
<b>Vis STHC</b> à bout plat		BAR	5111019G



Désignation		Code constructeur	Ref FHS
<b>Goupille de fixation</b> Ø12 Lg60mm			5124025
<b>Goupille de fixation</b> Ø8Lg50mm			5124026
<b>Goupille de fixation</b> Ø10mm		BAR	5124030
<b>Goupille élastique fendue</b> Ø6mm - Lg18mm		BAR	5124036G
<b>Goupille élastique fendue</b> Ø5,5mm - Lg18mm		BAR	5124037G
<b>Goupille élastique fendue</b> Ø5,5mm - Lg30mm		BAR	5124038G
<b>Vis à oeil M12</b> Lg 120mm a l'axe - M12		BAR	5124039G
<b>Goupille élastique fendue</b> Ø4,5mm Lg14mm		BAR	5124041G



Désignation		Code constructeur	Ref FHS
<b>Graisseur droit</b> M6		BAR	5219009
<b>Graisseur H1/180°</b>		BAR	5219010G
<b>Graisseur H3 / 90°</b>		BAR	5219011G
<b>Goupille élastique fendue</b> Ø12,5mm Lg50mm		BAR	5315036G

**BAR**



**PLATEFORMES & ACCESSOIRES**

**PLATEFORMES**

Acier

Désignation

Code constructeur

Ref FHS

Pour toutes vos commandes : **02 99 00 75 75**

france **hayon**

**BAR**



**PLATEFORMES & ACCESSOIRES**

**PLATEFORMES**

Aluminium

Désignation



Code constructeur

Ref FHS

Pour toutes vos commandes : **02 99 00 75 75**

france **hayon**



Désignation	Code constructeur	Ref FHS
<b>Volet butée de roll</b> 95mmx850mm	BAR	4010331
		
<b>Plaque verrouillage de sol</b>		4010332
		
<b>Verrouillage de volet Lg 80 mm</b>	BAR	4010360G
		
<b>Volet de butée de rolls</b> Lg 850mm	BAR	4010387G
		
<b>Axe de verrouillage de roll</b>		4012327
		
<b>Tige pour butée de rolls</b> Ø12mm Lg930mm	BAR	4012392
		
<b>Axe de butée de rolls</b> Ø12mm Lg50mm	BAR	4012449G
		
<b>Volet butée de roll</b> Lg 750mm	BAR	4013062G
		





Désignation		Code constructeur	Ref FHS
Verrouillage de volet butee de roll		BAR	4013063G
Encoche pour B.R.			5124032G
Ressort de pression			5313084
Ressort de butée de roll			5313117
Ressort à lamelle pour B.R.			5313129G
Ressort de butee de roll		BAR	5313142G
Kit butées de rolls			6011184



Désignation		Code constructeur	Ref FHS
<b>Rive latérale aluminium de P.F. (talon)</b> coté droite			4011259G
<b>Rive latérale aluminium de P.F. (talon)</b> coté gauche			4011260G
<b>Rive latérale aluminium de plate forme (pointe)</b> coté droit			4011261G
<b>Rive latérale aluminium de plate forme (pointe)</b> (coté gauche)			4011262G
<b>Pointe de rive pour plateforme</b>		BAR	4011295G
<b>Bord de rive talon</b> coté droit		BAR	4011303G
<b>Bord de rive cote droit</b>		BAR	4011306G
<b>Bord de rive talon</b> cote gauche		BAR	4011417G



Désignation		Code constructeur	Ref FHS
<b>Crochet de verrouillage plateforme</b>		BAR	4115001G
<b>Arceau de verrouillage de plateforme</b>			4115086G



Désignation

Code constructeur

Ref FHS









Désignation	Code constructeur	Ref FHS
<p><b>Butoir ressort</b></p> 	BAR	5222006G
<p><b>Butoir conique</b> Ø32mm - ht38mm - M8</p> 	BAR	5313150G
<p><b>Butoir ressort</b></p> 	BAR	5313151G
<p><b>Butoir caoutchouc</b> Ø100mm ep35mm</p> 		5315016
<p><b>Butoir arret ertalon</b> 72x58x46mm</p> 		5315017
<p><b>Butoir cylindrique ertalon</b> Ø100 ep35mm</p> 		5315018
<p><b>Butoir arret ertalon</b> 85x50mm ep35mm</p> 	BAR	5315024G
<p><b>Butoir conique</b> Ø30mm-ht36mm-M8</p> 	BAR	5315030G

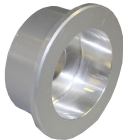





Désignation		Code constructeur	Ref FHS
<b>Support butoir ertalon biaise</b> Ø60mm		BAR	5315031G
<b>Butoir cylindrique</b> Ø50mm - ep17mm - filetage interieur M10		BAR	5315035G
<b>Butée repliage plateforme</b>		BAR	5315050G



Désignation	Code constructeur	Ref FHS
<b>Entretoise pour plateforme</b> 	BAR	4010376G
<b>Entretoise pour galet</b> 		4012358
<b>Pont de liaison</b> structure SCHMITZ 		4113180
<b>Pont de liaison</b> structure KRONE 		4113181
<b>Pont de liaison</b> structure KOGEL 		4113182
<b>Bouchon de barre anti encastrément</b> Ø125mm 	BAR	4114237G
<b>Galet de plateforme</b> Ø100 Ø30.3 ep50mm 		5012024
<b>Barre d'assistance de plateforme</b> 		5012033



Désignation	Code constructeur	Ref FHS
<p><b>Poignee pour plateforme</b></p> 	BAR	5012036G
<p><b>Galet de roulement d.45xD.100xEp.22</b> Ø100mm Ø45mm Ep.22</p> 		5015040
<p><b>Ecrou rivet</b></p> 		5128015
<p><b>Bouchon de barre anti encastrment Ø 110mm</b></p> 	BAR	5221038
<p><b>Sangle articulation de pliage</b></p> 	BAR	5315020